

4

3

2

1

MATERIAL & FINISH:

- 1 BODY: BRASS, ALBALOY PLATED
- 2 CENTER CONTACT: BRASS, SILVER PLATED
- 3 COUPLING NUT: BRASS, ALBALOY PLATED
- 4 RETAINING RING: PHOSPHOR BRONZE, UNPLATED
- 5 INSULATOR: PTFE
- 6 GASKET: SILICONE RUBBER

ELECTRICAL DATA:

- 1 IMPEDANCE: 50 Ω
- 2 FREQUENCY RANGE: DC~6 GHz
- 3 VSWR: 1.30 MAX.

ENVIRONMENTAL DATA:

- 1 TEMPERATURE RANGE: -55°C~+125°C
- 2 2011/65/EU (RoHS): COMPLIANT

REVISIONS

REV.	DESCRIPTION	DATE	APPROVED
A	INITIAL RELEASE	05/21/15	J. QU

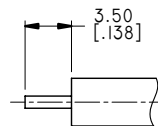
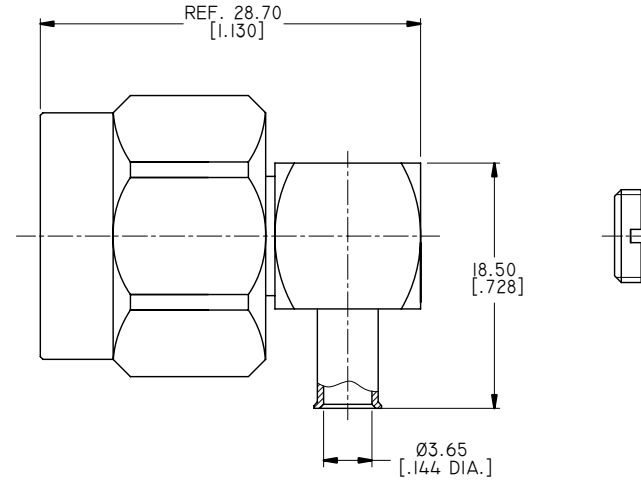

CABLE STRIPPING DIMENSIONS

DRAWN	X. B. YANG	DATE	05/21/15
CHECKED	P. CHEN	DATE	05/21/15
APPROVED	J. QU	DATE	05/21/15
UNLESS OTHERWISE SPECIFIED DIMENSIONS ARE IN MILLINMETERS, DIMENSIONS IN [] ARE IN INCHES FOR CUSTOMER REFERENCE ONLY UNLESS OTHERWISE SPECIFIED TOLERANCE ARE:		THESE DRAWINGS AND SPECIFICATIONS ARE THE PROPERTY OF ANOISON ELECTRONICS LTD AND SHOULD NOT BE USED WITHOUT WRITTEN PERMISSION COPYRIGHT © 2017 ANOISON ELECTRONICS LTD	
.XX	±0.13 [.005"]		
.X	±0.20 [.008"]		
X	±0.50 [.019"]		
X°	±1°		
X°	±2°		



TITLE
N RIGHT ANGLE MALE SOLDER FOR .141 CABLE

VIEW	PART NO. ANO 5121-2218		
	SIZE A3	SCALE 2.5:1	SHEET 1/1
	REV. A		

4

3

2

1