

Main Specifications

Impedance: 50Ω
 Frequency range: DC~67GHz
 VSWR: ≤1.25
 Dielectric withstanding voltage(V.R.M.S.): 750V
 Durability: ≥500

Material / Plating

Body: Stainless steel Passivated
 Center Conductor: Beryllium copper Gold
 Insulators: PEI

1.85mm(m) to 1.85mm(m)

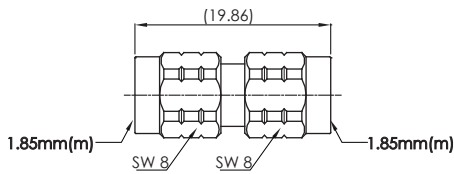

PA6262A

1.85mm(m) to 1.85mm(f)

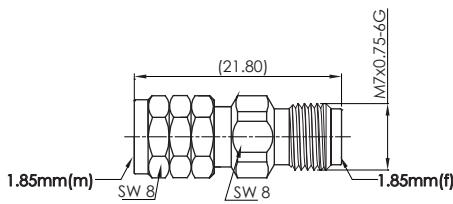

PA6262BA

1.85mm(f) to 1.85mm(f)

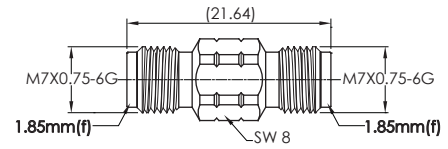

PA6262C

NMD1.85mm(f) to 1.85mm(f)

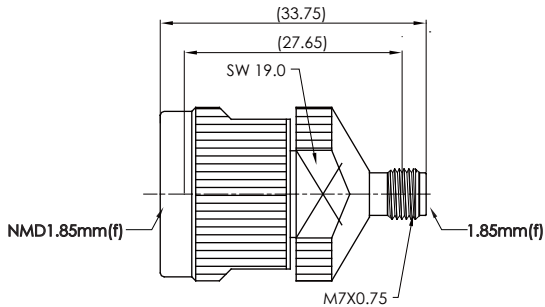

PA6962C

NMD1.85mm(f) to 2.4mm(f)

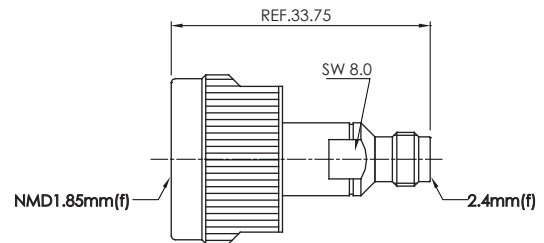

PA6922C

NMD1.85mm(f) to NMD2.4mm(m)

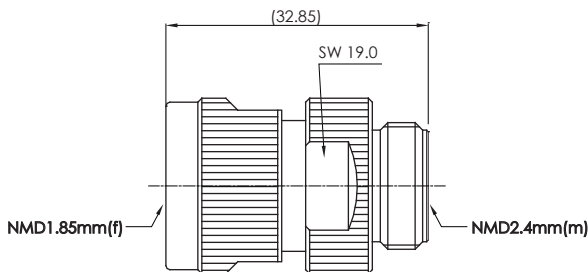

PA6968B

NMD1.85mm(f) to NMD1.85mm(m)

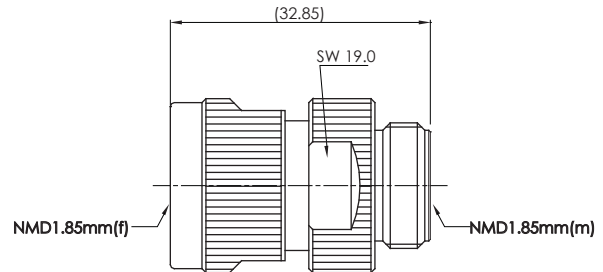

PA6969B